

VERSION - R

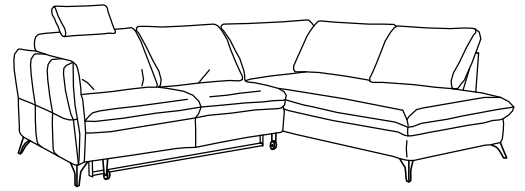

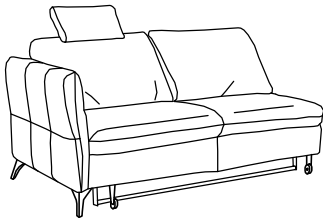

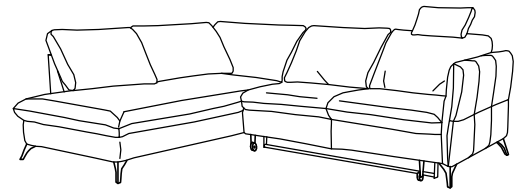

VERSION - L

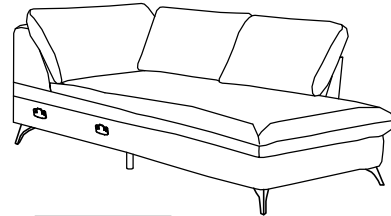

3FBL

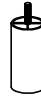

OSP

| | | | | |
|---|---|---|---|---|
| M8.0x40mm  |  | 4.0x25mm  |  | 4.0x50mm  |
| A | B | C | D | E |
| 6 | 6 | 12 | 1 | 4 |

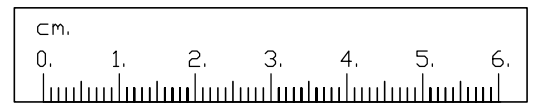

1

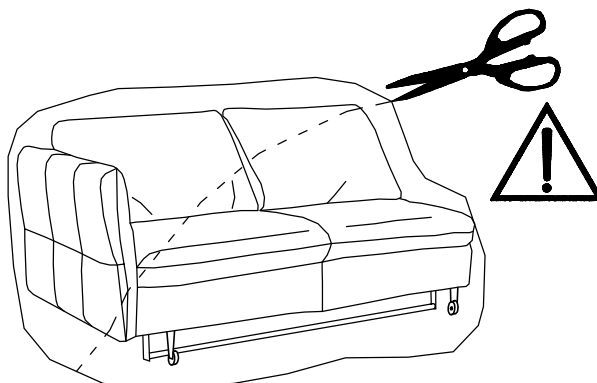

3FBL



2

3FBL

13

| | | |
|--|--|--|
| M8.0x40mm  A |  B | 4.0x50mm  E |
| 2 | 2 | 4 |

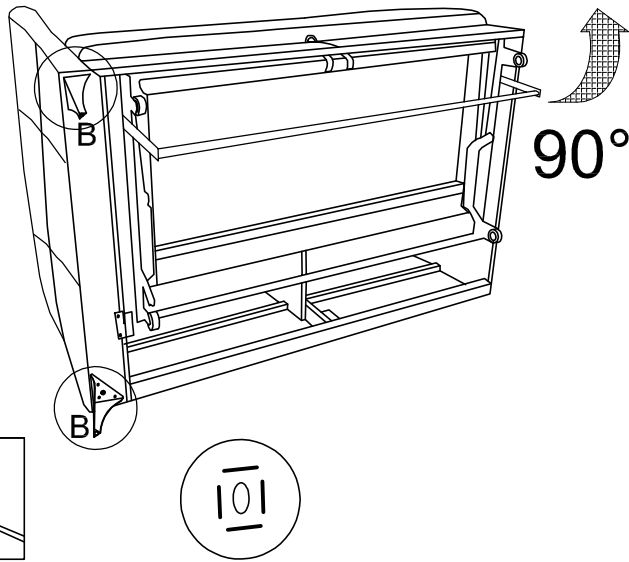

3FBP

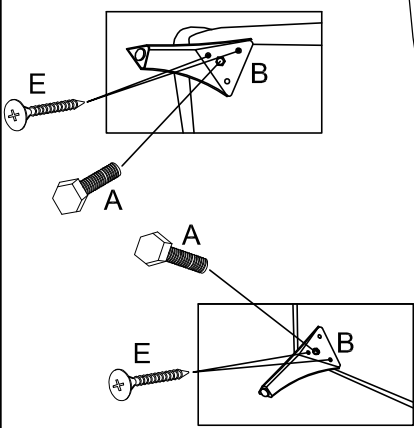
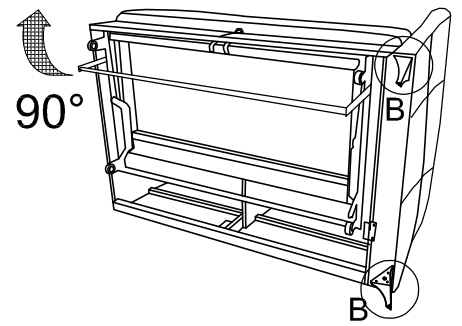



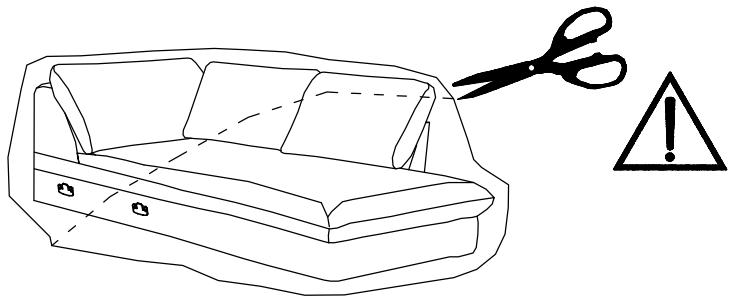

3

OSP



4

13

| | | | |
|--|--|--|--|
| M8.0x40mm  A |  B | 4.0x25mm  C |  D |
| 4 | 4 | 12 | 1 |



OSP

90°

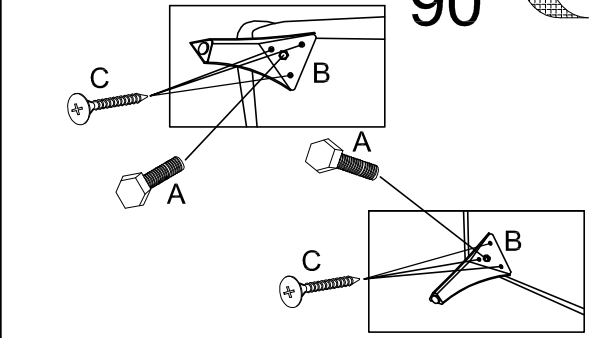
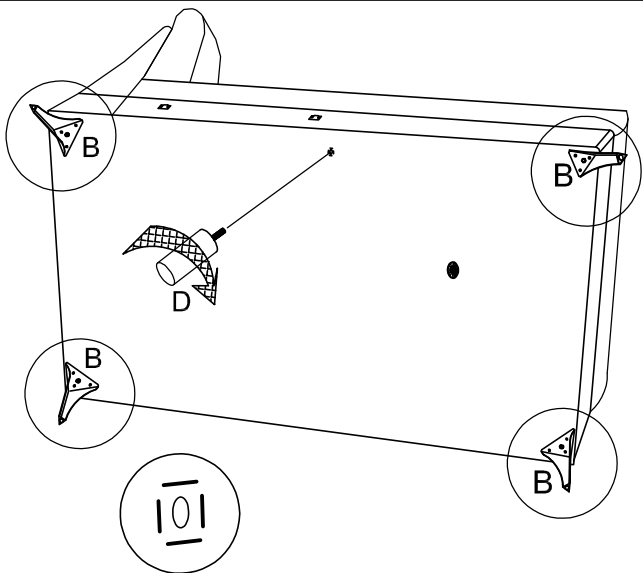

5

3FBL

OSP

OSL

3FBP

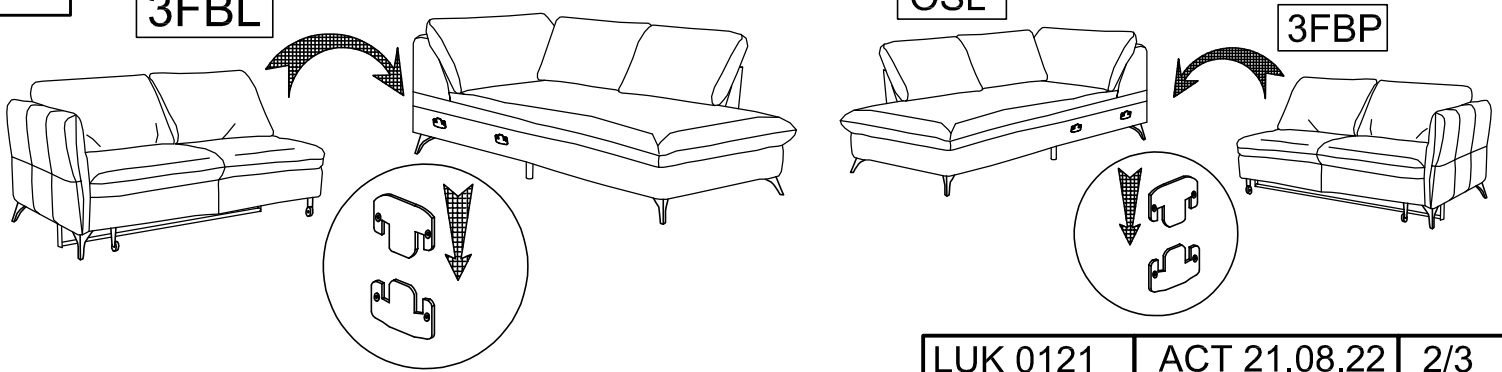

6

3FBL

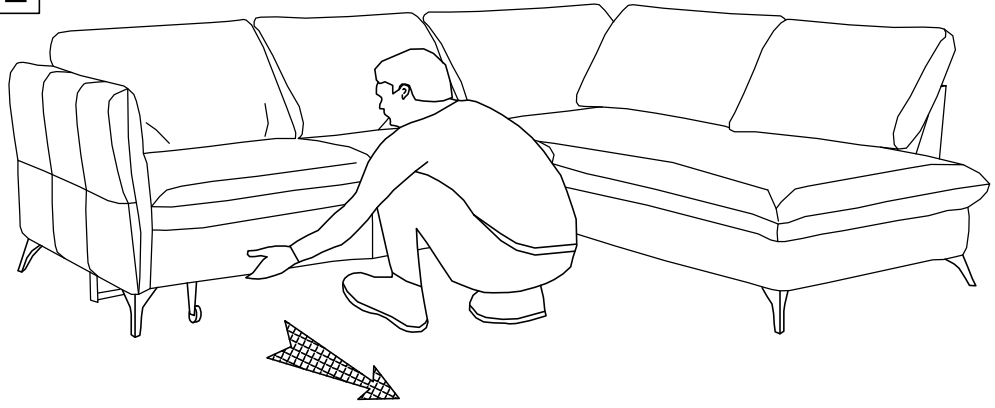

7

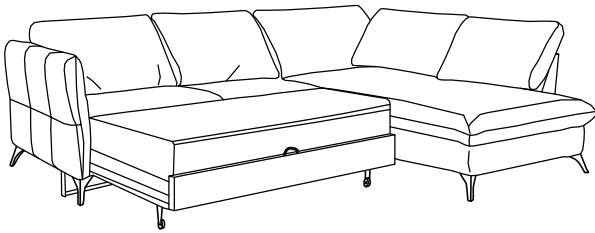
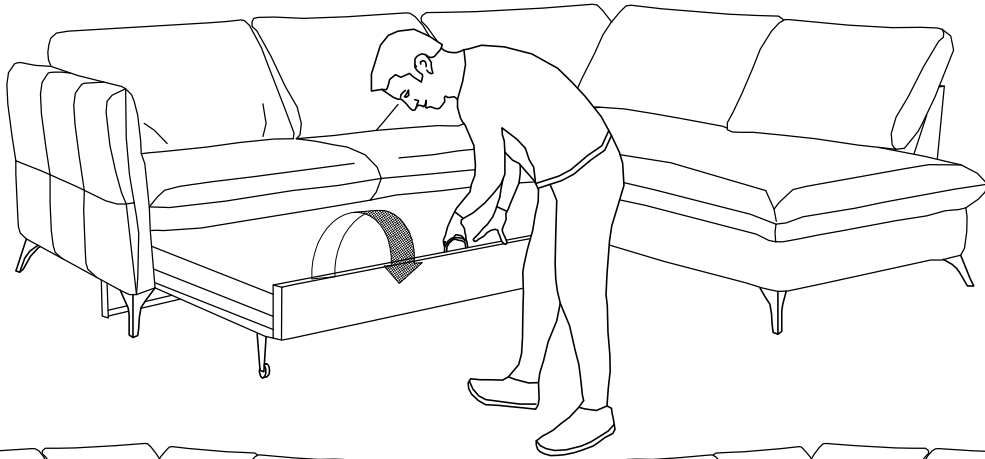

3FBL

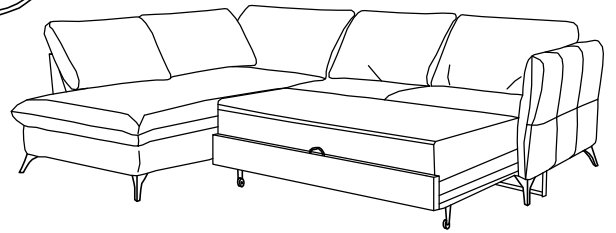

3FBP

8

OSL

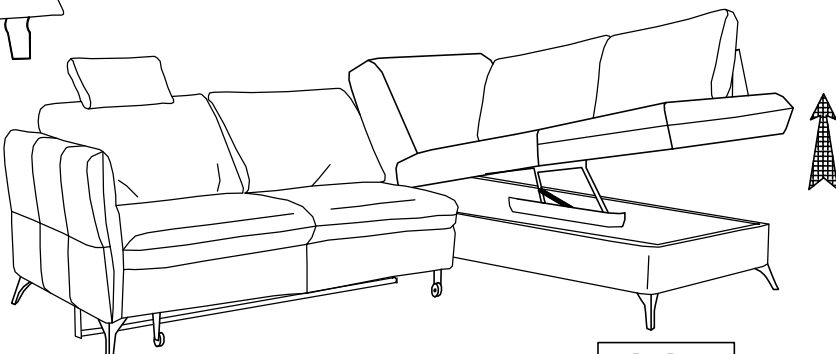
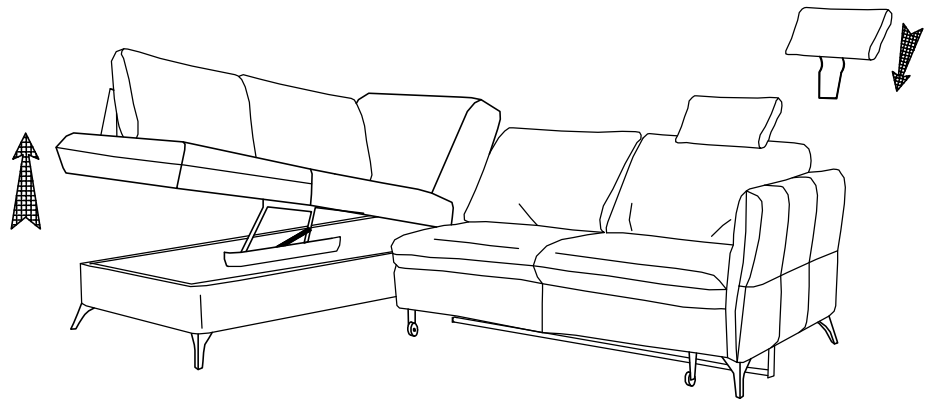

OSP

