

VERSION - R

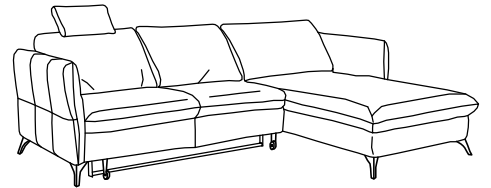

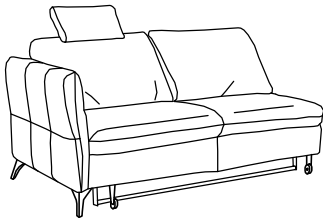

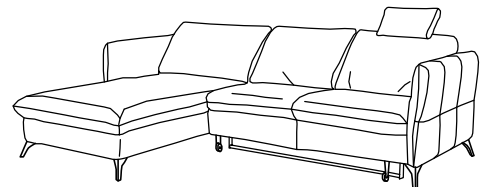

VERSION - L

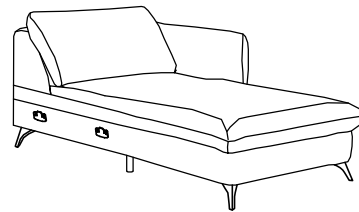

3FBL

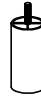

OSBP

M8.0x40mm  A	 B	4.0x25mm  C	 D	4.0x50mm  E
6	6	12	1	4



1

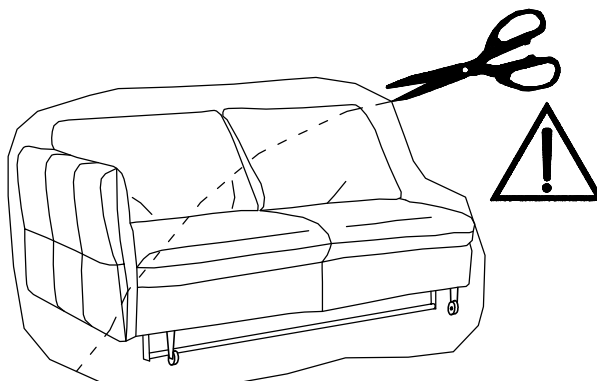

3FBL



2

3FBL

13

M8.0x40mm  A	 B	4.0x50mm  E
2	2	4

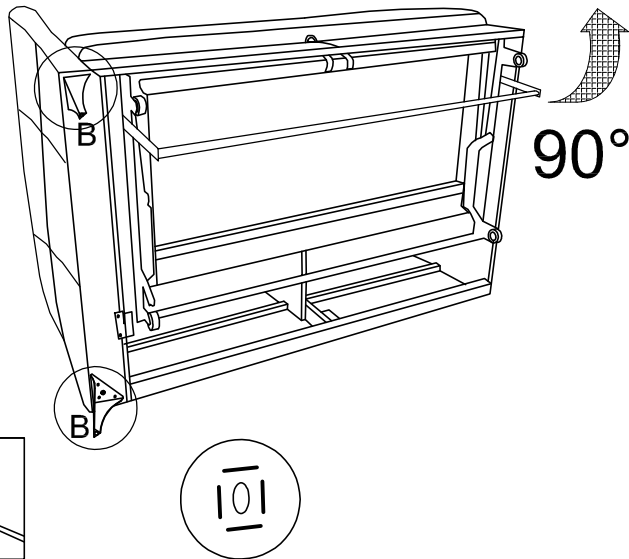
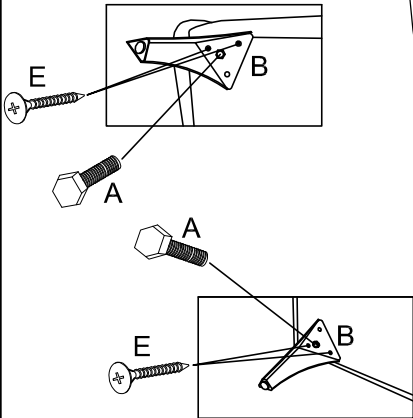

3FBP

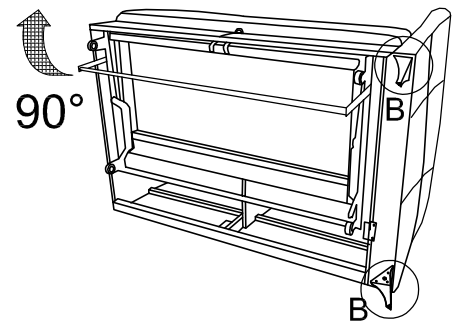



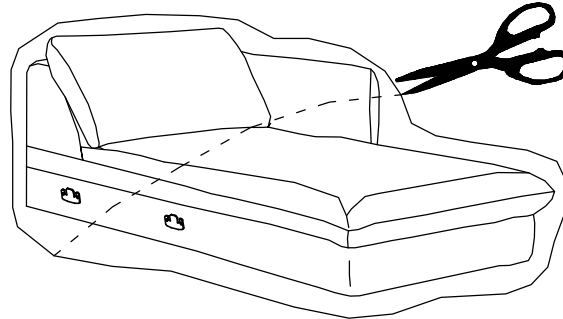

3

OSBP



4

M8.0x40mm  A	 B	4.0x25mm  C	 D
4	4	12	1

13

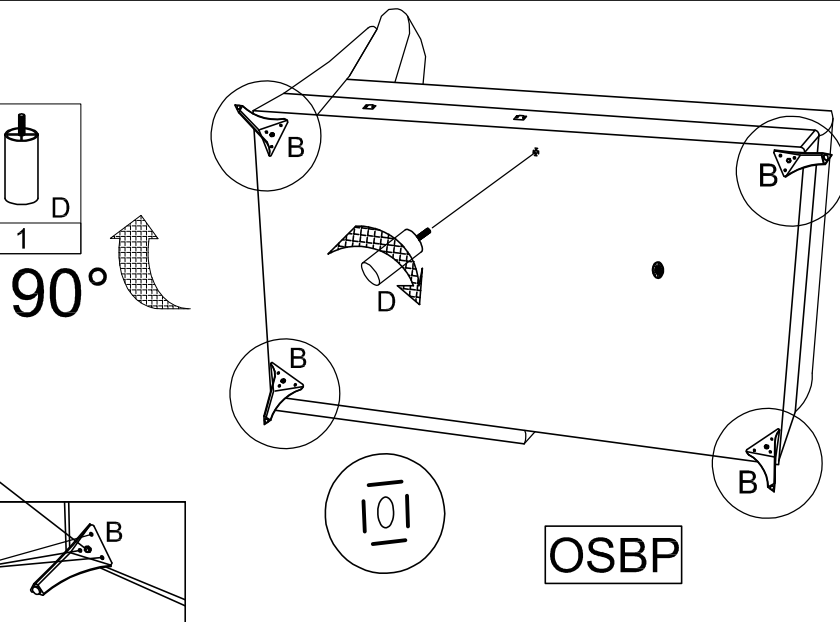

OSBP

5

3FBL

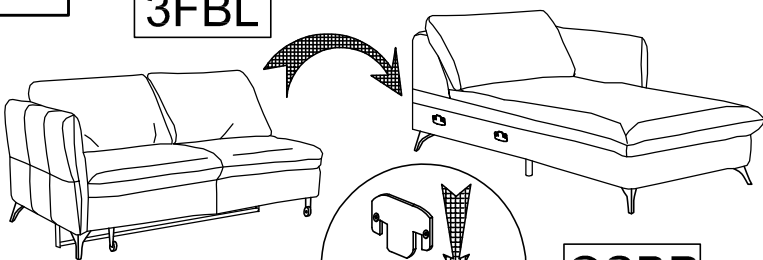

OSBP

3FBP

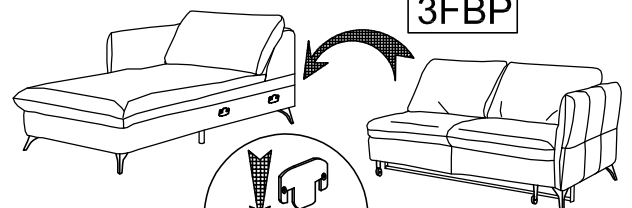

OSBL

6

3FBL

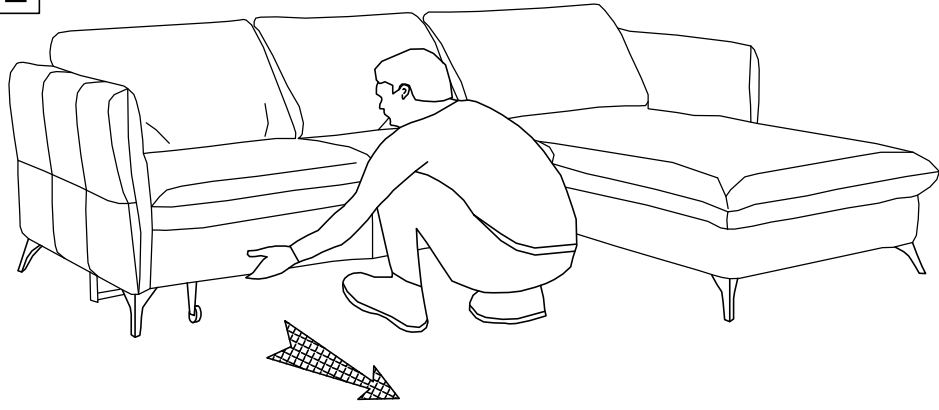

7

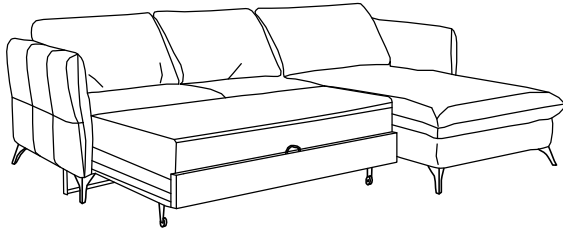
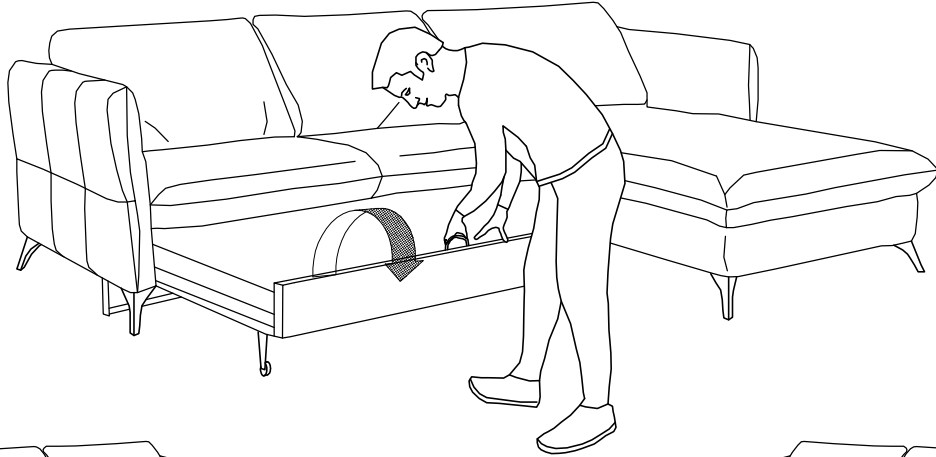

3FBL

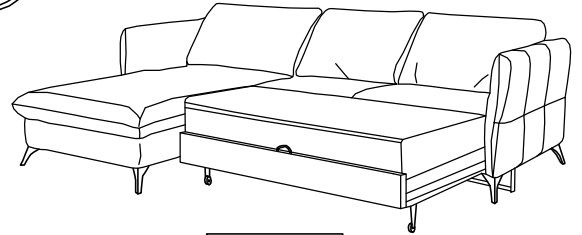

3FBP

8

OSBL

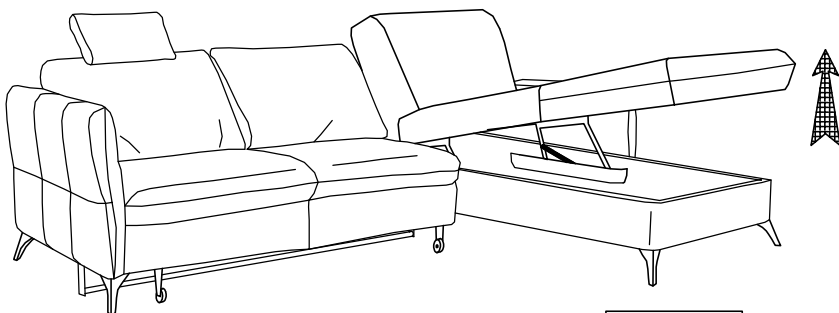
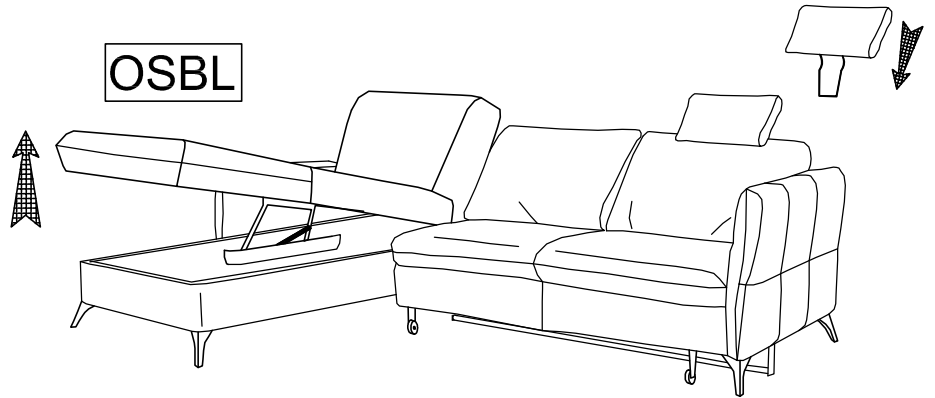

OSBP

